

CST STUDIO SUITE®

Electromagnetic and Multiphysics Simulation Software

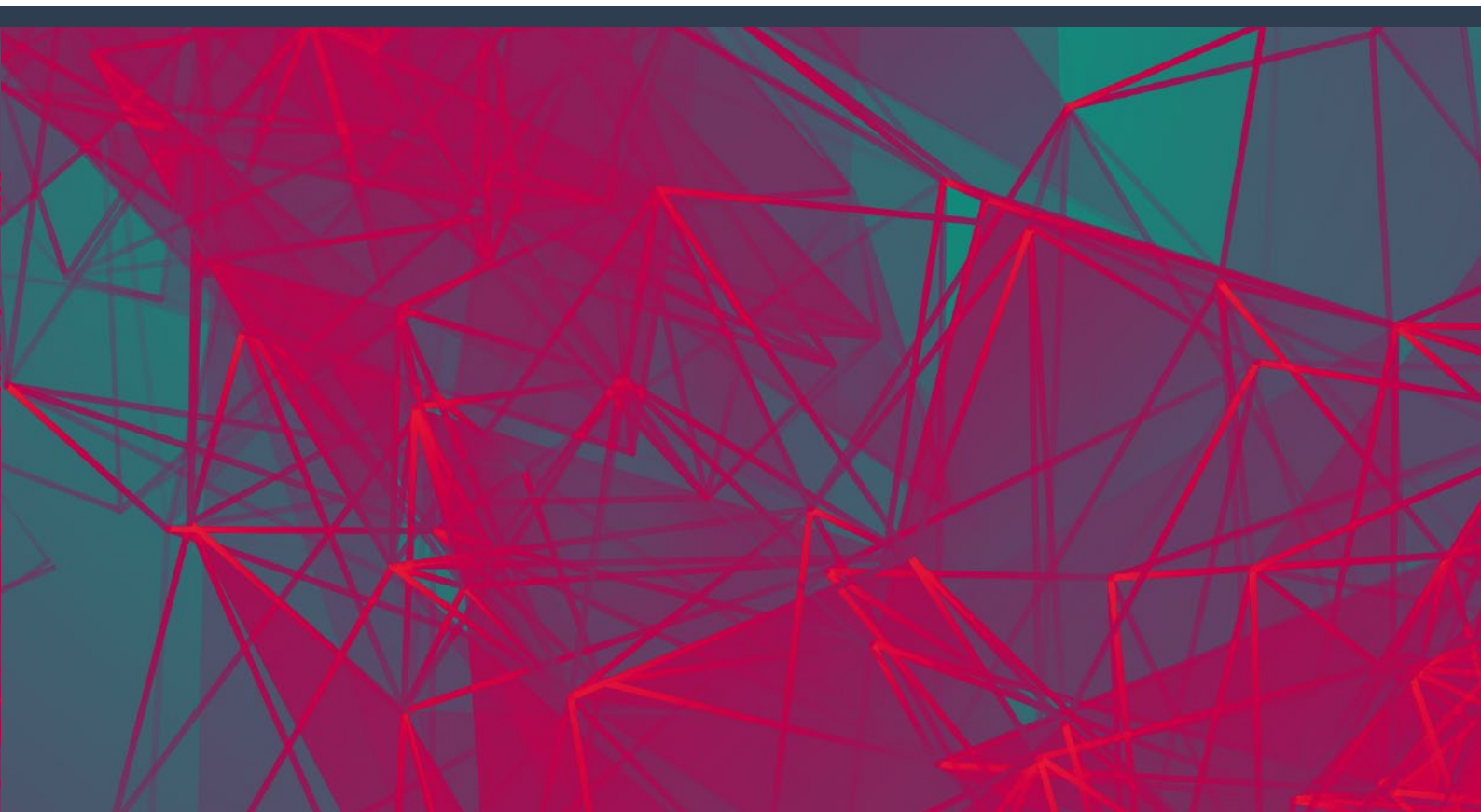

joins





Discover

CST STUDIO SUITE 2018

WHY SIMULATE?

Getting the design right first time is the ideal for product development. With virtual prototyping electromagnetic simulation can help you to cut down design iteration cycles. Simulation allows systems and components to be analyzed and optimized in their environment from the earliest stages of development. This can make the design process faster, reducing development costs and time-to-market.

WHY CHOOSE CST STUDIO SUITE?

CST STUDIO SUITE® is a package of tools for designing, simulating and optimizing electromagnetic systems, and is used in leading technology and engineering companies around the world. The three pillars of CST® products are accuracy, speed and usability.

ACCURACY

Proven solver technology forms the basis of each module in CST STUDIO SUITE, the culmination of years of research and development into accurate and efficient computational simulation techniques. CST is also continually developing and refining modeling and meshing technologies to allow the simulation to represent the real world better.

To learn more, see page 4.

SPEED

Speed and accuracy go hand in hand. Whether the problem is electrically large or small, broadband or narrowband, the range of solvers in CST STUDIO SUITE allows problems varying from the simple to the complex to be simulated efficiently. High-performance computing (HPC) and optimization can extend the capabilities of the solvers even further.

To learn more, see page 9.

USABILITY

CST invests considerable development time into tools to improve the user experience. These include the workflow-oriented ribbon GUI, import and export tools for numerous design flows, and System Assembly and Modeling (SAM). SAM allows complex systems or workflows to be broken down into simpler parts to be simulated automatically.

To learn more, see page 13.

By keeping these three concepts at its core, CST STUDIO SUITE has become widely used by engineers, designers and researchers working in many fields, including microwaves, RF & optical, EDA & electronics, electromagnetic compatibility (EMC), particle dynamics, statics and low frequencies. To learn about some of the applications that CST STUDIO SUITE has been used to simulate, see page 22.

ACCURACY

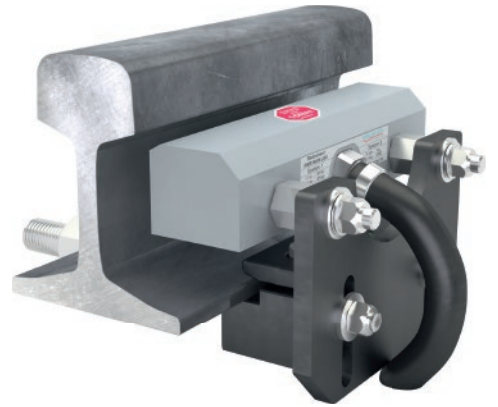
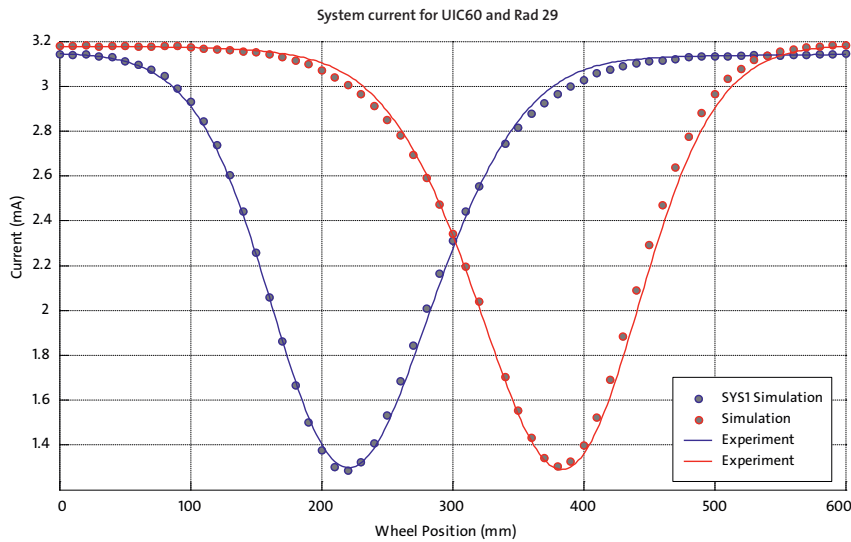

Accurate simulation: Excellent agreement between simulation and measurement in the response curves of a Frauscher RSR180 wheel sensor.

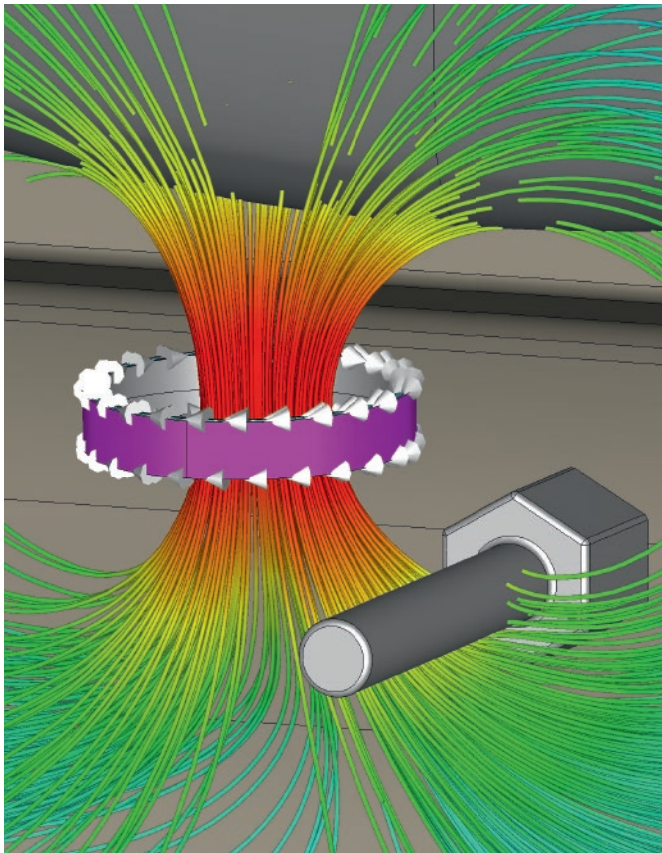

Sensor coil: Magnetic field lines from a coil in a rail wheel sensor, showing coupling through the wheel.

“CST STUDIO SUITE gave us the ability to quickly and accurately model our sensors including all complex interactions with the surrounding environment that just wouldn’t have been possible experimentally. The additional understanding will be invaluable in designing our future generations of sensors. In addition, I commend the friendly and competent CST staff who, albeit indirectly, equally contributed to the success of our models...”

Dr. Gavin Lancaster, Developer, R&D Sensors, Frauscher Sensor Technology

COMPLETE TECHNOLOGY

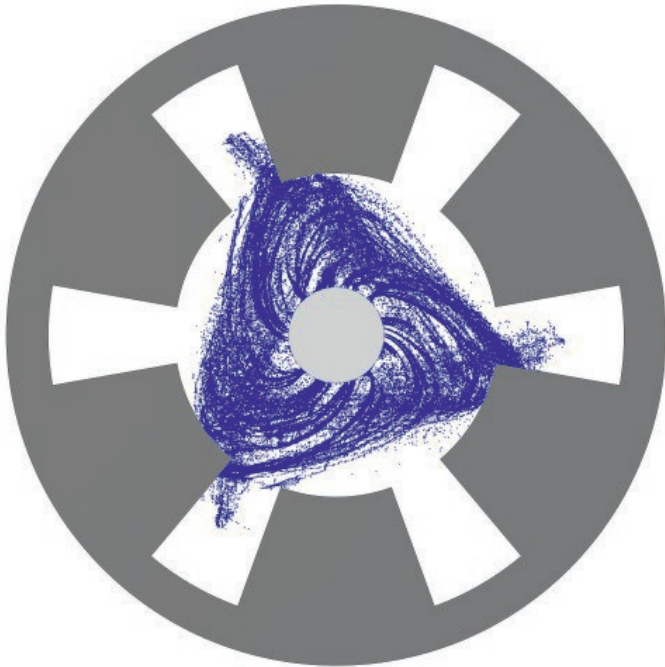

Complete Technology: Simulating a magnetron requires high-frequency, static, thermal, mechanical and particle effects to be taken into account.

To ensure that CST simulation technology remains at the cutting edge, its solvers are under continuous development, and represent decades of research into accurate and efficient computational techniques. This accuracy has allowed customers in many application areas who use CST STUDIO SUITE to construct **virtual prototypes** that mimic the behavior of the real device, saving time and money in the design cycle.

The solver types available include general-purpose **Time Domain** and **Frequency Domain Solvers** for both high frequency and low frequency problems, along with a full-wave **Integral Equation Solver**, **Eigenmode** and **Asymptotic Solvers**, a self-consistent **Particle-in-Cell (PIC) Solver**, **statics** and **multiphysics** solvers, and many more specialized solvers as well as hybrid solver combinations. These solvers offer an accurate, versatile approach for tackling many applications.

For some applications, multiple simulation methods can be employed on the same model. The CST Complete Technology approach makes it possible to verify a simulation by comparing the results from several different solvers within a single interface. Cross-checking the simulation in this way improves confidence in its accuracy.



Touchscreen



Transformer

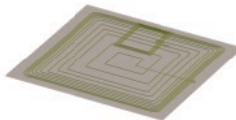

Wireless charging



RFID



Mobile

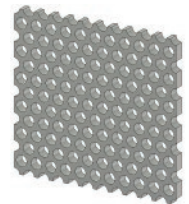

Photonics



EM spectrum: CST STUDIO SUITE includes solvers for problems spanning the EM spectrum.

POWERFUL MODELING TOOLS

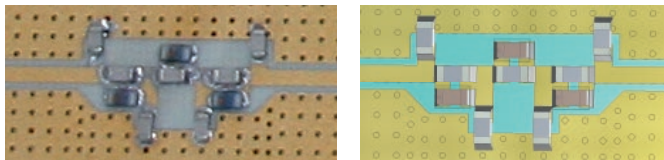
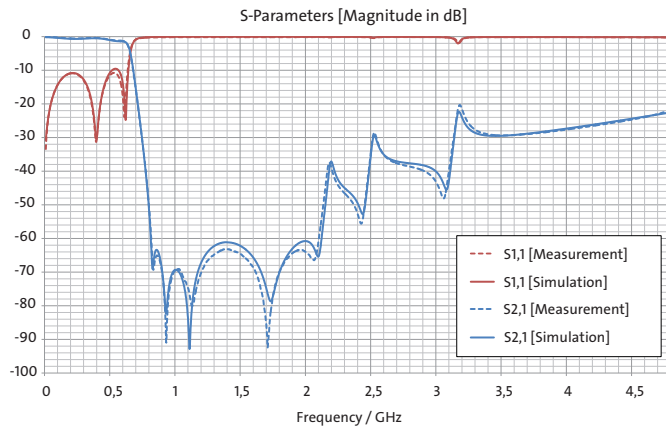

Realistic simulation: Realistic material models and circuit elements allow this SMD filter to be simulated with excellent accuracy.

An accurate simulation requires an accurate model. This means that the model has to represent the real-world object and capture the full range of phenomena that can affect its EM performance. CST STUDIO SUITE includes a **powerful modeling environment** and **CAD import tools** to help the user build up a useful, representative model of the system.

There are many application areas, such as magnetics and photonics, where the characteristic electromagnetic effects only come about as a result of the non-linear materials used in the devices. CST STUDIO SUITE includes numerous material models to allow a vast array of phenomena to be simulated, including plasmonic and photonic effects, ferromagnetism, secondary electron emission and biological heating.

True transient EM/circuit co-simulation adds the ability to incorporate SPICE circuits and non-linear components such as diodes and transistors into a 3D model. The broadband nature of the transient simulation means that multiple harmonics are automatically taken into account.

Measured data can also be imported into CST STUDIO SUITE – for example, the properties of a sample of material or the near-field of an antenna or the S-parameters of a semiconductor device. These can be integrated into the model to improve its representation of the physical system.

MATERIAL TYPES IN CST STUDIO SUITE INCLUDE:

- Dielectrics
- Lossy metals
- Anisotropic materials
- Time-dependent materials
- Temperature-dependent materials
- Graded materials
- Dispersive materials
 - Drude model
 - Debye model
 - Lorentz model
 - Electric and magnetic gyrotropic
- Non-linear materials
 - Second and third order non-linear
 - Kerr model
 - Raman model
 - Non-linear magnetic materials
- Coated materials
- Radar absorbing materials
- Layered thin panel materials
- Surface impedance materials
- Secondary electron emission surfaces
 - Furman model
 - Vaughan model
- Non-linear thermal and bio-heat materials
- Graphene
- Ferrites

Electromagnetism is closely linked to other fields of physics, including mechanics and thermodynamics. Multiphysics analysis is therefore necessary in the design of many different components, from motors and generators to induction heaters and microwave ovens. In many cases, electric and magnetic effects are inseparable from thermal and mechanical effects – for example, a high-power filter will heat up when in use, and this can cause thermal deformation that affects the performance of the filter.

To calculate these intertwined thermal and mechanical effects, CST STUDIO SUITE includes **Stationary Thermal, Transient Thermal, Conjugate Heat Transfer (CHT) Solvers** and a **Structural Mechanical Solver**. The multiphysics solvers are tightly linked to the EM and PCB solvers, and simulations can be automatically set-up using the System Assembly and Modeling (SAM) framework (see page 21). With SAM, the calculated temperature distribution and deformation can be transferred back to the EM simulation for sensitivity analysis and can be used for convergence studies to calculate the steady-state solution of devices that include EM-thermal feedback loops.

To support multiphysics simulation, CST STUDIO SUITE supports a range of non-linear and **temperature-dependent materials**. For biological applications such as MRI and RF diathermy, the unique thermal properties of body tissues – for example, cooling due to blood flow which varies according to body temperature – can have a significant effect on the temperature within the body. The thermal solvers include the **bio-heat equations**, allowing the realistic simulation of devices within the human body. The CHT Solver also includes **computational fluid dynamics**, allowing the flow of air through devices to be simulated to model **electronics cooling**.

The link to SIMULIA® strengthens CST's multiphysics offering further. For more information, see page 16.

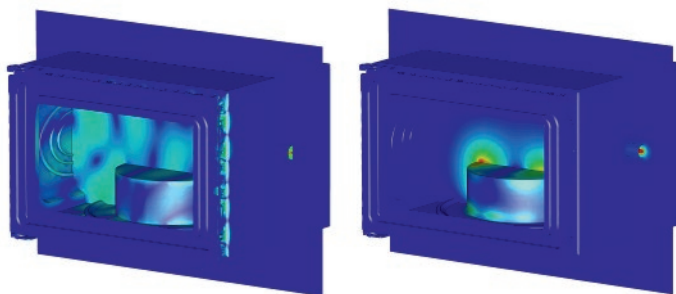

Microwave oven: Multiphysics simulation of a microwave oven (door mesh not shown) – left: electric field at 2.45 GHz, right: temperature distribution after 30 seconds.

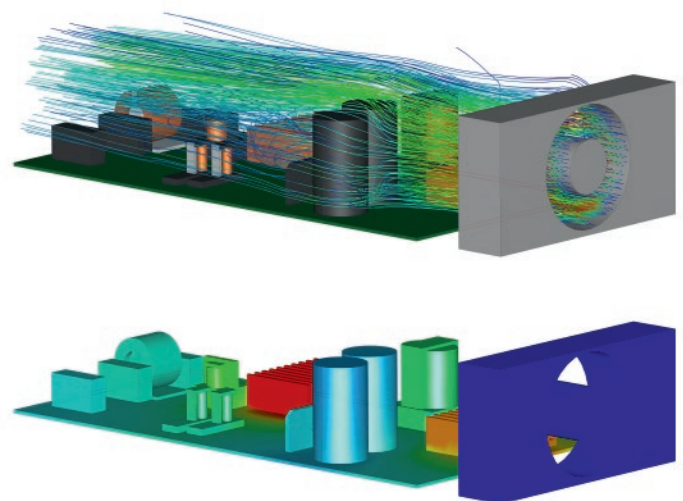

Electronics cooling: Airflow over a PCB, and the resulting steady-state temperature distribution.

ROBUST, ACCURATE MESHING

Meshing techniques: Various meshing strategies for a simple reflector antenna: staircase, curved tetrahedral, curved hybrid surface, and the proprietary CST technology PBA.

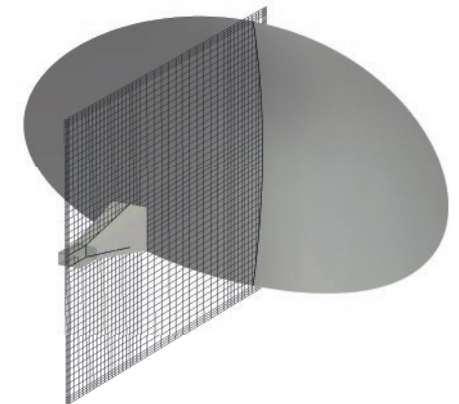
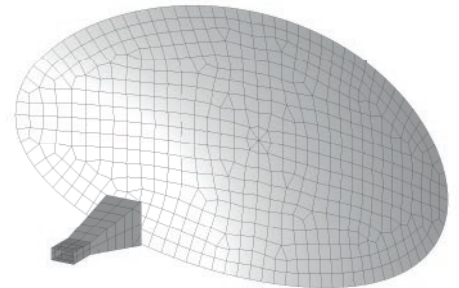
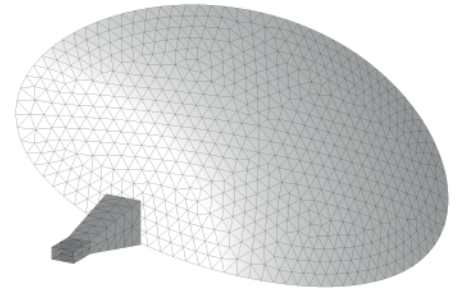
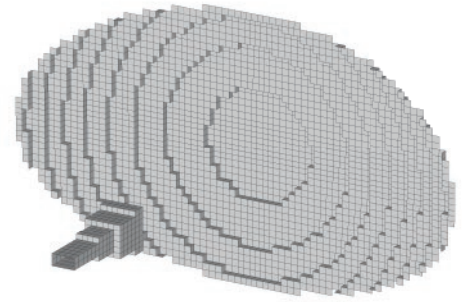

In simulation, structures and fields are discretized onto a mesh. Each additional cell increases the computational requirements of the simulation, which means that it is advantageous if the mesh accurately describes the model while using as few mesh cells as possible. CST STUDIO SUITE includes **hexahedral** and **tetrahedral** volume meshes and **hybrid triangular and quadrilateral** surface meshes, with different approaches suitable for different situations.

To improve the accuracy of the hexahedral mesh without affecting performance, CST STUDIO SUITE uses the **PERFECT BOUNDARY APPROXIMATION (PBA)**[®] in its Transient Solver. PBA retains the speed advantages associated with a conventional staircase mesh, but allows curved structures to be modeled accurately without requiring an extremely dense mesh.

The tetrahedral mesh and the surface meshes can take advantage of **curved elements** in both high and low frequency simulations. In addition, the mesh refinement algorithms of the Frequency Domain Solvers can use **CST True Geometry Adaptation**. This projects the refined mesh back onto the original model, smoothing out the coarse, faceted mesh and allowing greater accuracy in the simulation.



Wi-Fi coverage simulation:

Electric field from a Wi-Fi antenna at 2.45 GHz inside a bus, simulated with the Transient Solver.

SOLVER TECHNOLOGIES A selection of the solver types available in CST STUDIO SUITE.

High frequency

- **Transient Solver** – general purpose
- **Frequency Domain Solver** – general purpose
- **Integral Equation Solver** – electrically large structures, RCS
- **Asymptotic Solver** – installed performance, RCS
- **Eigenmode Solver** – resonant cavities
- **Multilayer Solver** – planar structures
- **Filter Designer 2D** – RF filter analysis and synthesis
- **Filter Designer 3D** – cross-coupled filter analysis and synthesis
- **Hybrid Task** – hybrid simulation with multiple solvers

Low frequency

- **Electrostatic & Magnetostatic Solvers** – fast static simulation
- **Stationary Current Solver** – DC applications
- **Time Domain Solver** – non-linear materials, transient effects
- **Frequency Domain Solver** – eddy currents, displacement current
- **System Simulator** – multi-domain and state-space simulation

EDA

- **PEEC Solver** – Partial equivalent circuit extraction
- **Transmission Line Solver** – signal integrity
- **3D FEFD Solver** – power integrity
- **CST BOARDCHECK** – EMC and SI on PCBs

Particle dynamics

- **Particle Tracking Solver** – low energy particles, electron guns
- **Particle-in-Cell (PIC) Solver** – high energy particles, RF devices
- **Wakefield Solver** – accelerator components

Multiphysics

- **Thermal Solvers** – electromagnetic heating, bio heat, electronic cooling
- **Structural Mechanics Solver** – thermal expansion, deformation

EMC

- **Transmission Line Matrix (TLM) Solver** – general purpose, EMC
- **CST CABLE STUDIO** – cable harness simulation
- **Interference Task** – RF interference analysis
- **Rule Check** – EMC and SI on PCBs

THE RIGHT SOLVER FOR THE JOB

“With the help of CST STUDIO SUITE and the implemented high-performance solver techniques, we were able to verify the RF communications requirements and to establish reasonable EMC requirements for the various units and instruments on the spacecraft.”

Dr.-Ing. Christian Imhof, Satellite Products, Airbus Defence and Space

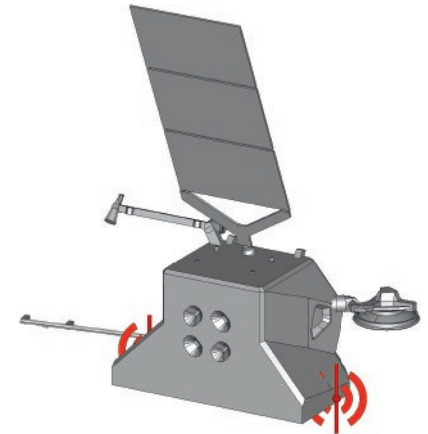

Spacecraft antenna placement: Simulation model of the BepiColombo Mercury Planetary Orbiter. Low-gain antennas are represented by field sources (red).

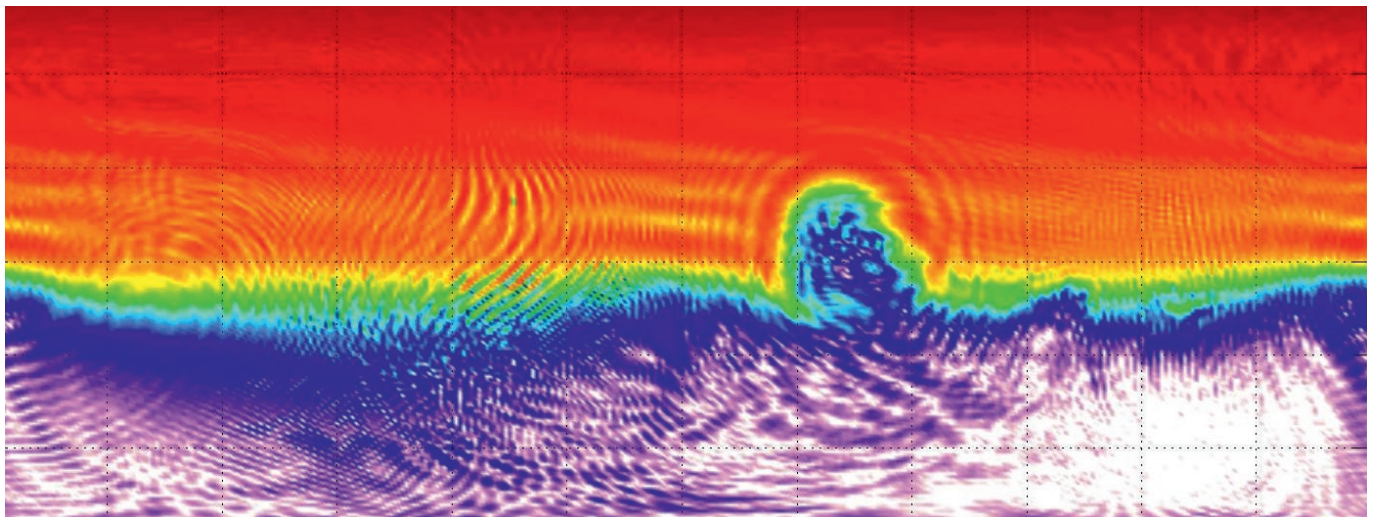

Antenna performance: Radiation pattern for one low-gain antenna simulated with the MLFMM Integral Equation Solver, showing shadowing from the high-gain antenna.

Simulation performance is the combination of speed and accuracy that allows the user to get useful results quickly. A solver which works efficiently on one type of model may be a poor choice for a different one. This is why CST STUDIO SUITE includes a wide range of different solvers. With Complete Technology, there are tools for applications at frequencies ranging from statics up to optics, and from the nanoscale to the electrically very large.

For example, the **Integral Equation Solver** and the **Asymptotic Solver** are ideally suited to problems such as antenna placement and radar cross-section (RCS), where the structures of interest

can be hundreds or thousands of wavelengths long. Small, resonant structures on the other hand can be simulated much more efficiently using the **Eigenmode Solver** or the **Fast Resonant Frequency Domain Solver**, which are designed for models such as filters and accelerator cavities.

Many systems contain multiple components, each of which is best suited to a different solver. In these cases, System Assembly and Modeling (SAM) can be used to break the device down into multiple smaller models. Each one can then be simulated with a suitable solver, with the fields from each stage of the calculation being transferred automatically into the next (see page 21).

HIGH PERFORMANCE AND CLOUD COMPUTING

“GPU computing has allowed us to perform some complex simulations that were previously impractical.”

Matt Fuller, Selex ES

CST offers a multitude of hardware-based simulation acceleration options, such as **multithreading**, **hardware acceleration**, **MPI cluster computing** and **distributed computing**. These can be used to increase the speed of a simulation, to simulate larger and more complex models, or to divide tasks between multiple nodes in a network or cluster. These high-performance computing (HPC) methods are available for almost every type of application and hardware configuration, ranging from individual workstations to enterprise-level clusters.

In order to help make the most of investments and make it easier to choose the most effective acceleration solution for a given simulation model, CST uses an acceleration token licensing scheme. This enables greater versatility in accessing and combining high-performance computing options, allowing acceleration methods to be mixed and matched.

For small businesses with big requirements, CST STUDIO SUITE can also be run in the cloud. With **cloud computing**, models can be transferred securely over the internet to the HPC computing provider and the calculations carried out using their hardware. This means that users who occasionally have very demanding simulations to run can access HPC without the cost of installing and maintaining dedicated hardware.

Because high-performance hardware represents a significant investment, our hardware experts are available to advise users who are considering purchasing or upgrading HPC systems, and review hardware configurations. CST offers also benchmarking services, in collaboration with vendor test centers, to help ensure that the chosen hardware configuration offers excellent performance for CST STUDIO SUITE.

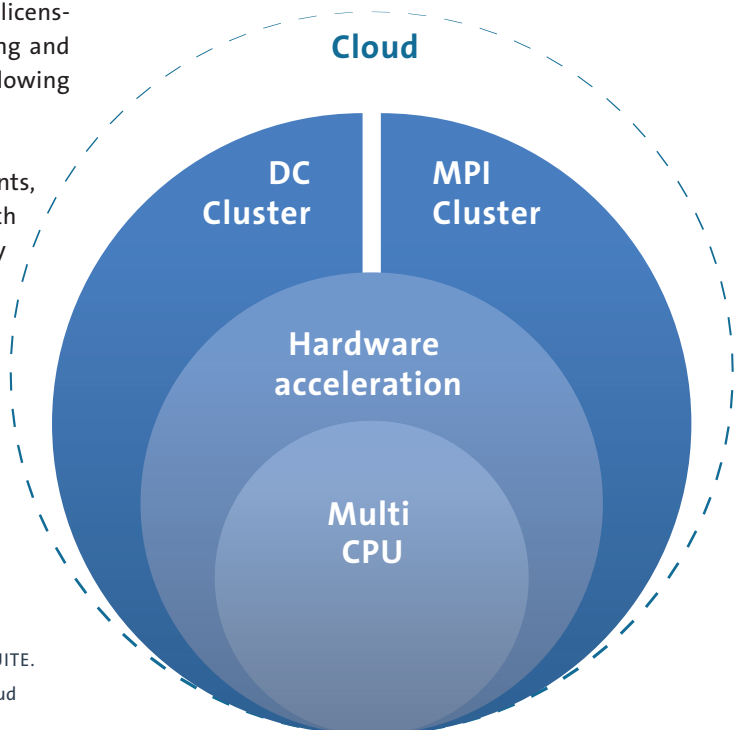

HPC options: Some of the HPC combinations available in CST STUDIO SUITE. All of these can be accessed with both on-site hardware and through cloud computing. Different solvers support different HPC techniques.

AUTOMATIC OPTIMIZATION

Antenna optimization: A microstrip patch array, optimized to improve transmission in the WLAN frequency band, before (left) and after (right) optimization.

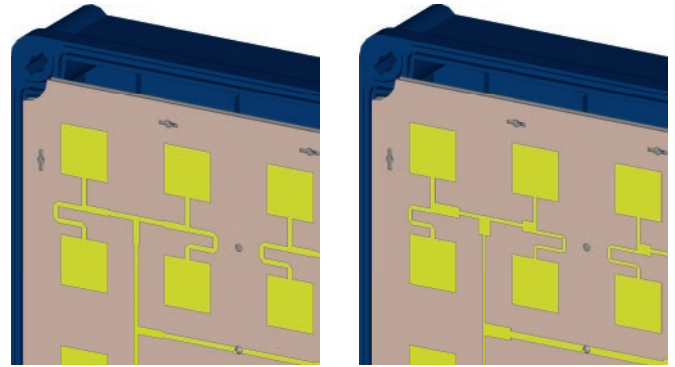

The number of variables that affect the performance of even the simplest device can be overwhelming. Optimization automates the process of tuning these variables, with the goal of finding a set of values that satisfies the design requirements. The built-in optimizers in all CST STUDIO SUITE modules can be used to optimize any parameter, including the geometry of the model, material properties, waveform excitation, and with the link to Filter Designer 3D, the filter coupling matrix itself.

CST STUDIO SUITE includes both local and global optimizers. Local optimizers search the parameter space close to the initial values – they offer fast performance for fine-tuning a nearly optimal model. Global optimizers on the other hand search the entire parameter space, and are more efficient than local techniques for complex structures and those where the initial values are far from the optimum.

The Trust Region Framework optimizer can take advantage of sensitivity information. This allows it to investigate the effect of small changes to the model quickly, which can offer a major speed-boost to the optimization. Sensitivity can also be used to carry out a yield analysis, which calculates the effect of manufacturing tolerances on the behavior of a device using just a single simulation. For PCBs, Pareto front optimization can be used to optimize the placement of decoupling capacitors to reduce bill of materials while maintaining performance.

Filter tuning: A filter optimized with the Trust Region Framework, showing S-parameters before and after optimization.

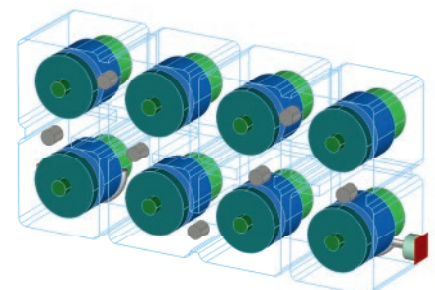

OPTIMIZERS IN CST STUDIO SUITE

Local

- Trust Region Framework
- Nelder-Mead Simplex Algorithm
- Interpolated Quasi-Newton
- Classic Powell

Global

- Genetic Algorithm
- Particle Swarm
- Covariance Matrix Adaptation Evolutionary Strategy (CMA-ES)

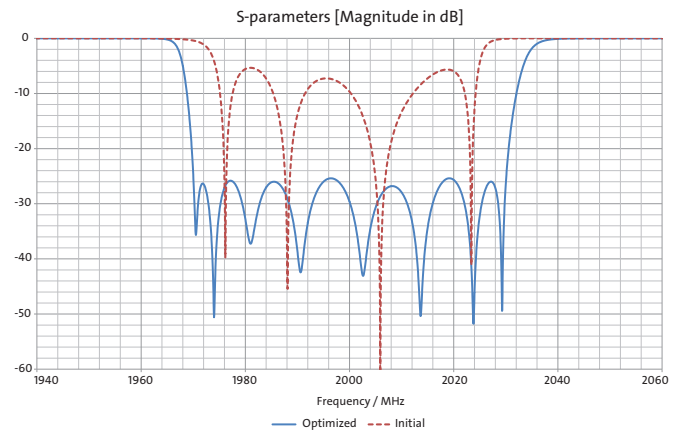

USABILITY

USER FRIENDLY INTERFACE

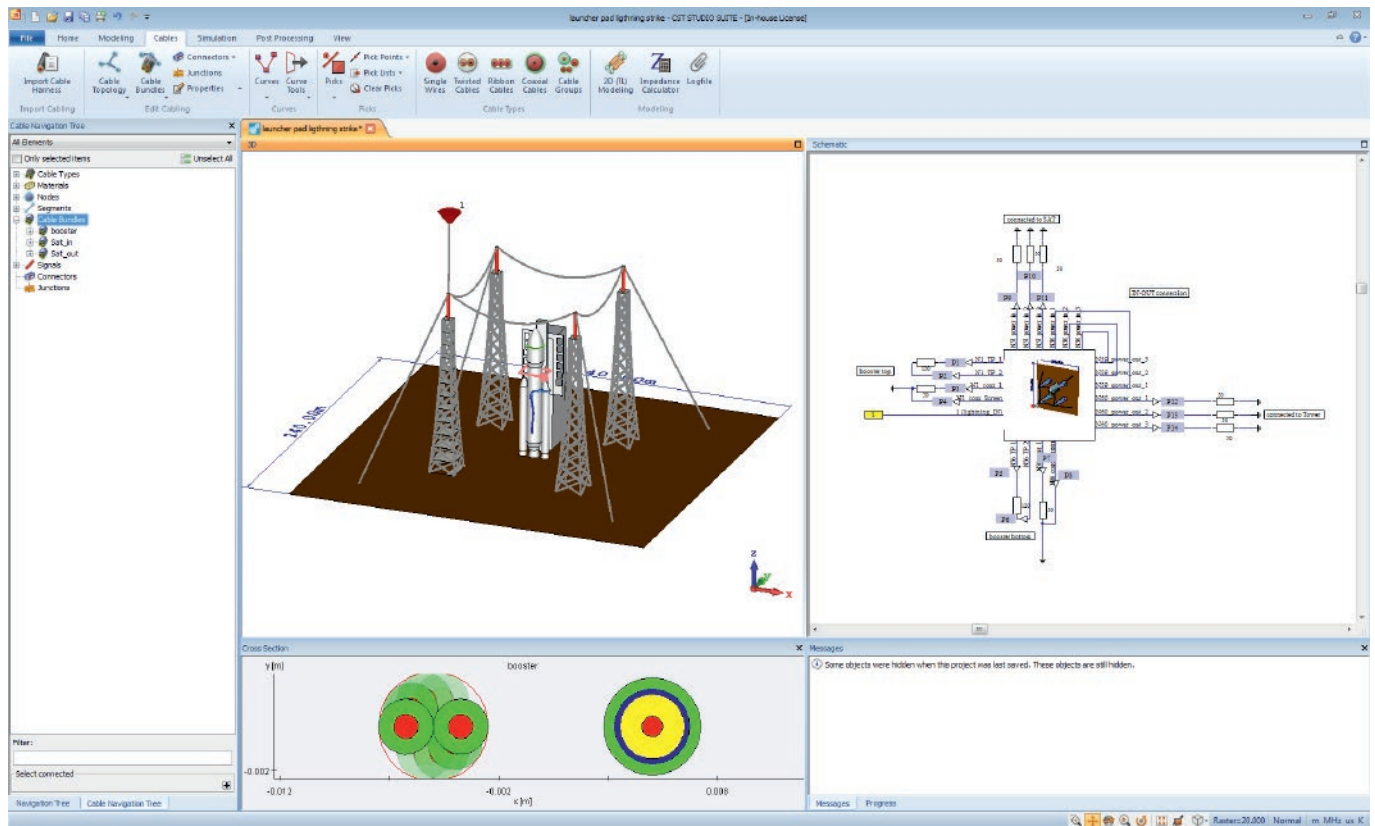

GUI: The user interface helps simplify the set up and simulation of models such as this lightning simulation.

With so many features in CST STUDIO SUITE, it's important to have the tools on hand when they're needed. To help users find their way through the simulation process, CST STUDIO SUITE includes features that set up the simulation environment for the user's needs, outline the modeling, simulation and post-processing workflow and show the appropriate options for each step of the process.

The **graphical user interface** uses tabbed ribbons to present the most relevant tools for each step of the design process, and it is automatically configured according to the application. The user interface is common to all of the modules within CST STUDIO SUITE, offering a consistent environment for all the different steps of the simulation workflow.

The **project wizard** in CST STUDIO SUITE allows the user to easily set up and configure the workspace for a simulation, with the appropriate units, boundary conditions and solver settings automatically chosen for the problem. The nature of the design cycle means that engineers often find themselves running the same sort of simulation over and over again. To help with this, custom configurations based on the user's personal experience of the best approach to a problem can also be stored and loaded with the wizard for a more personalized workflow.

CAD AND EDA IMPORT

A wide range of **import/export filters** enable the easy exchange of geometrical data with CAD tools, and imported structures can be **modified, parameterized**, and used for optimization and design studies. Models from SOLIDWORKS® and PTC Creo™ (Pro/E) can be imported in fully parameterized format, increasing workflow integration further.

The ability to import and export structural information is fundamental to fitting simulation into the design workflow. Imports from EDA tools are particularly prone to small gaps and edges which unnecessarily complicate the simulation model. To deal with these, CST STUDIO SUITE contains a **sophisticated cleaning procedure** as well as **automatic healing**. Combined with the robust mesher, these features enable effective simulation even for corrupt CAD data.

To meet the special requirements of integrated circuit design, CST offers the **CST Chip Interface**. This module imports 2D chip layout files and mimics the IC fabrication process to produce realistic 3D chip models.

SUPPORTED FORMATS INCLUDE

CAD

- ACIS SAT
- STEP
- STL
- OBJ
- NASTRAN (solid and mesh)
- IGES
- PTC Creo™ (Pro/E)
- Autodesk Inventor®
- CATIA® v4 – v6
- SOLIDWORKS and Solid Edge
- Parasolid
- Siemens NX™
- Biological voxel data

EDA

- ODB++
- IPC-2581
- Zuken CR5000/CR8000
- GDSII
- SPICE
- Touchstone
- Single and multi-layer Gerber
- Mentor Graphics® Expedition™
- Mentor Graphics Board Station®
- Mentor Graphics HyperLynx®
- Cadence® Allegro® PCB Designer
- Cadence Allegro Package Designer
- Cadence SiP Digital Layout
- Agilent ADS®
- AWR Microwave Office®
- Synopsis® HSpice, Saber
- Sonnet®
- Harness Description List
- Cadence Virtuoso®
- Si2 OpenAccess

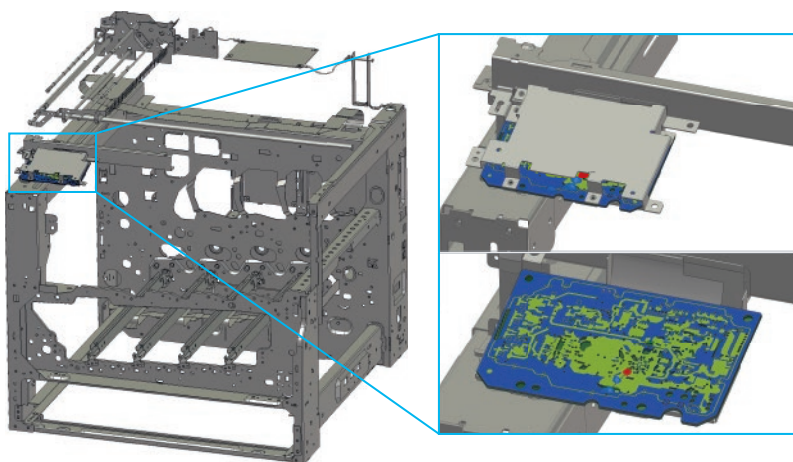

Imported data: The metal frame and PCB of a printer, imported into CST STUDIO SUITE for EMC analysis. With simulation, Fuji Xerox engineers were able to predict EMC problems before constructing the prototype.

WORKFLOW INTEGRATION

CST consistently promotes the best-in-class approach by specializing in developing 3D EM software and providing straightforward, easy-to-use links with other leading vendors to connect all available expertise.

Special interfaces to various EDA tools and RF circuit/system simulators unite and build on the capabilities of different worlds. The powerful VBA-based and OLE-compatible macro language allows direct communication with programs like MATLAB® or MS Excel®. CST STUDIO SUITE can also extract HSPICE netlists representing channels in a chip-package-board co-simulation, which can be passed on to Synopsys® HSPICE® for simulation and analysis.

CST STUDIO SUITE is a key part of the wider ecosystem, and includes links to many other simulation and design tools. Many workflows can be complemented by specialized software tools such as Antenna Magus® for antenna synthesis, Optenni Lab™ for matching circuit optimization, by SPARK3D for RF breakdown analysis, FEST3D for waveguide component synthesis and IdEM for macromodeling. These products can interface with CST STUDIO SUITE and are sold and supported through CST channels.

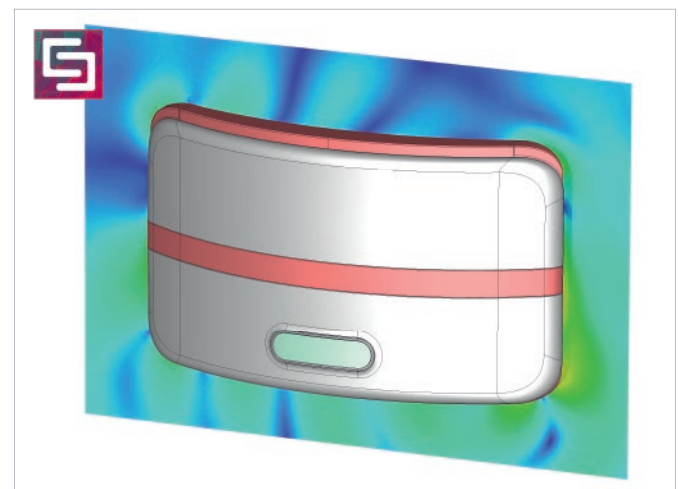
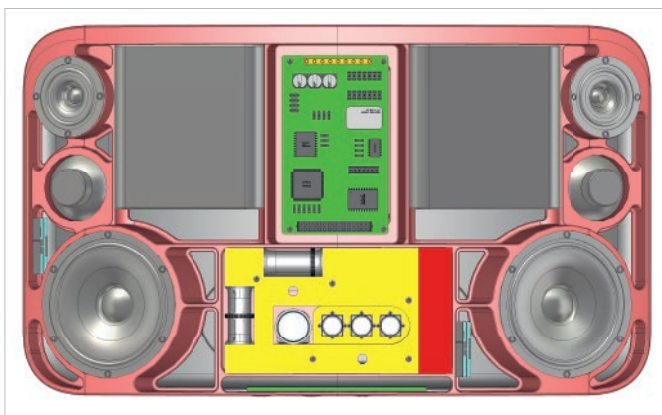
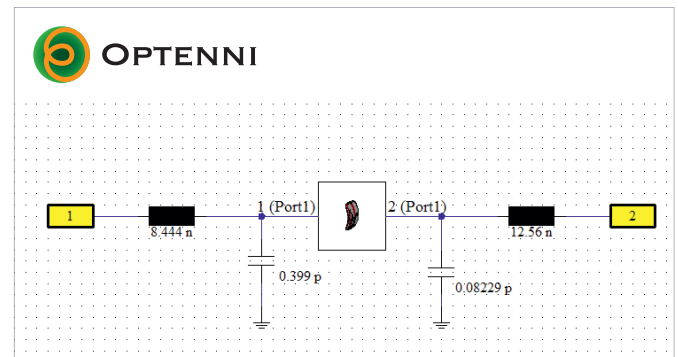
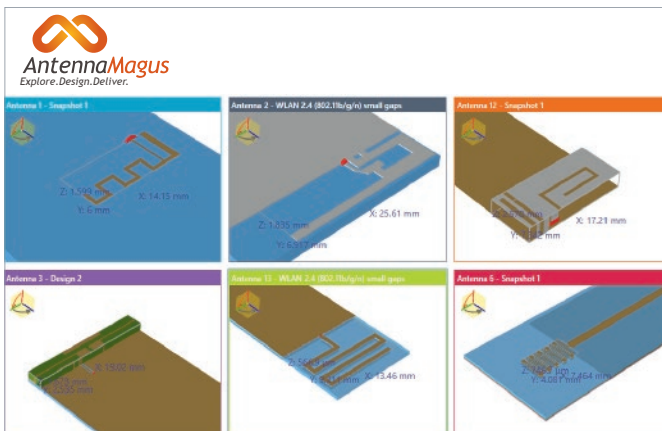

Integrated workflow: In the design of this smart projector (bottom left), Antenna Magus was used to design the antennas (top left), Optenni Lab was used to synthesize the matching circuit (top right), and CST STUDIO SUITE was used to calculate the performance of antennas installed in different places on the body.

STRUCTURAL AND ELECTROMAGNETIC CO-DESIGN

Since October 2016, CST has been part of the SIMULIA family of Dassault Systèmes. SIMULIA offers simulation tools to support many areas of design and manufacturing. The smartwatch project demonstrates some of the many benefits of co-design in modern electronics development, and how combining CST STUDIO SUITE with other simulation tools can significantly speed the design process and reduce the need for testing.

The smartwatch in this example has a central module with a touchscreen and several additional modules in the strap, linked by flexible connectors. There are many parts of the design where structural and electromagnetic effects interact, including deformation due to finger pressure on the screen, and the robustness and signal integrity of the connectors.



Co-Design: The CST-SIMULIA smartwatch.

Touchscreen

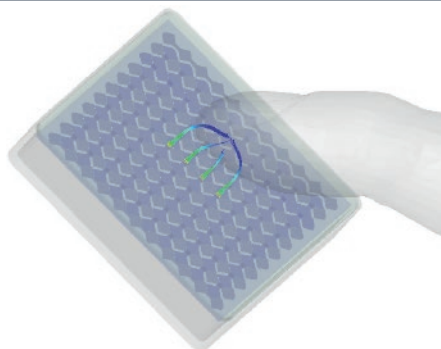

Capacitance matrix: CST Electrostatic Solver.

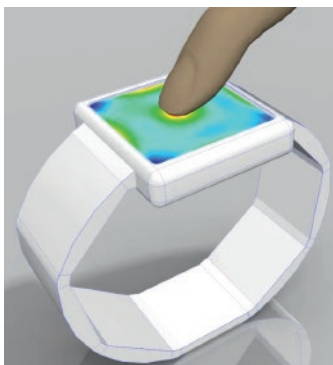

Screen stress: Abaqus/Standard.

Electromagnetic Compatibility

Tx	WiFi Tx	LVDS Tx	GSM Tx
Rx			
GSM Rx	Green	Yellow	
WiFi Rx		Yellow	Green
GPS Rx	Green	Yellow	Green

RF Interference: CST Interference Task.

Connector

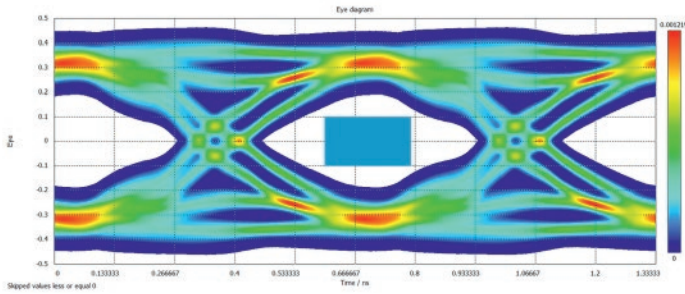

Eye Diagram: CST DESIGN STUDIO.

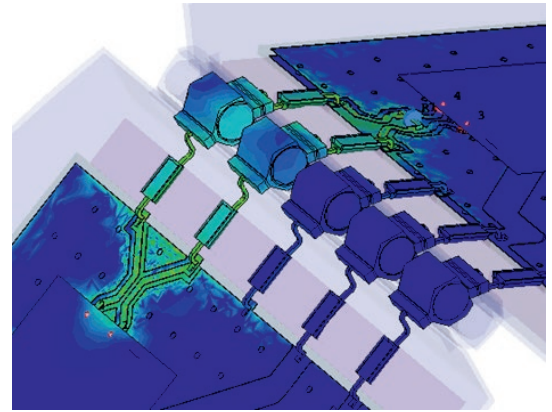

Signal Integrity: CST Time Domain Solver.

Robustness: Abaqus/Standard.

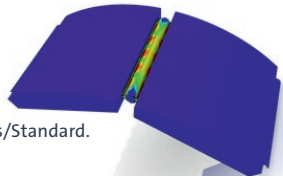

Antennas

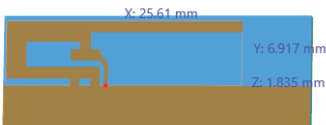

Antenna design: Antenna Magus.

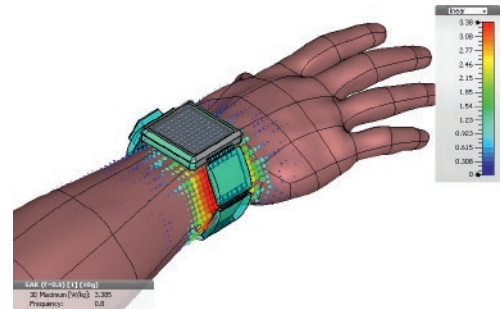
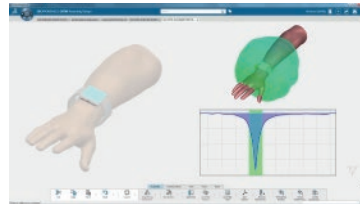

Specific Absorption Rate (SAR): CST Time Domain Solver.

Body

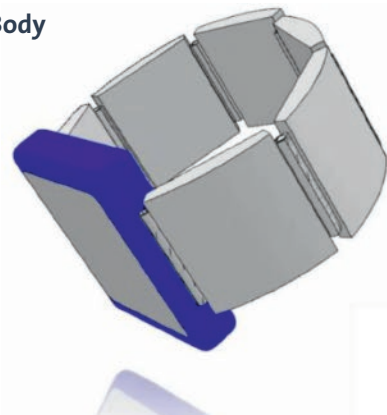

Drop

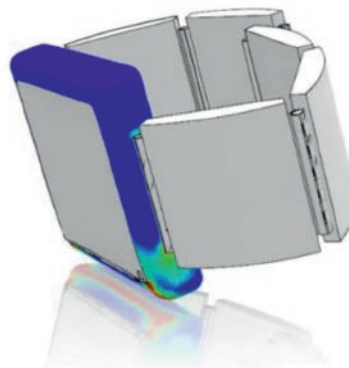

Impact

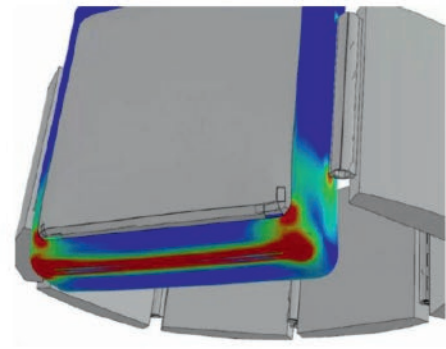

Deformation

Drop simulation: Abaqus/Explicit.

FILTERS

Filter design and optimization is a major application of CST STUDIO SUITE, and the software includes a set of tools for every step of the filter workflow, including initial synthesis, fine-tuning, thermal analysis and breakdown analysis.

The starting point for a filter design is the specification. These design requirements typically include not only the pass and stop frequencies, but also transmission and reflection zeroes, pass-band ripple and Q-factor, as well as budget, space and thermal demands. The first challenge faced by the designer is to choose a filter topology that can fulfill the requirements while remaining within the constraints. To help engineers find a suitable filter type and synthesise an initial design, CST STUDIO SUITE includes **Filter Designer 3D (FD3D)** for cavity, cross-coupled and diplexer filters, and **Filter Designer 2D (FD2D)**, for planar filters. These can be used to create circuit-level and 3D models of filters for further simulation. **Coupling matrix extraction** with FD3D offers an efficient way to fine-tune 3D filter structures.

A real filter will behave slightly differently to the mathematical ideal due to effects such as material properties, couplings and the influence of connectors. Simulation with CST STUDIO SUITE can not only identify these effects, but mitigate them through **optimization**. The powerful optimizers (see page 12) and fast frequency domain solver can tune large sets of design parameters effectively. The **moving mesh optimization** reduces the ‘mesh noise’ associated with tuning very sensitive filters dramatically, allowing filters to be tuned faster and more precisely.

When in use, electromagnetic losses can cause filters to heat up and expand. Multiphysics simulation (see page 7) combines EM simulation with thermal and mechanical simulation, allowing the **thermal detuning** of filters to be analyzed before constructing prototypes. In addition, the link to the CST Particle-in-Cell (PIC) Solver and SPARK3D allows the simulation of **multipaction and RF breakdown (corona)**.

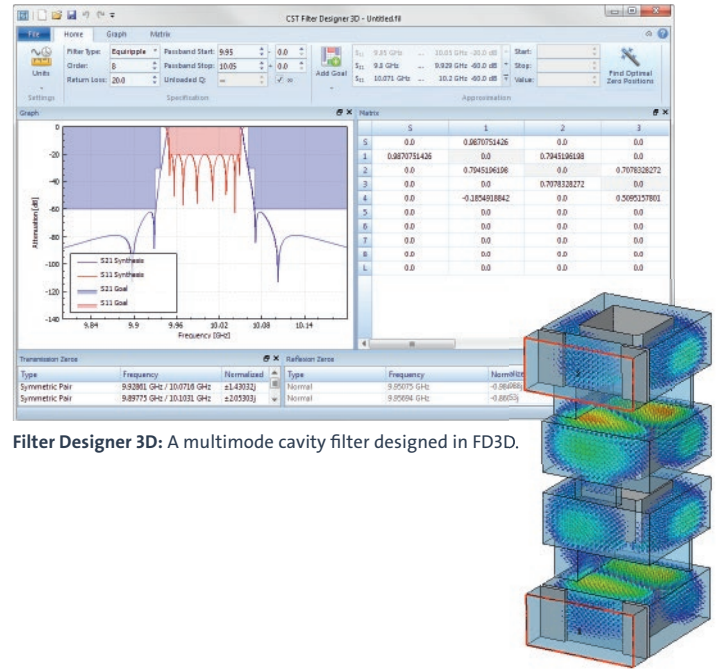

Filter Designer 3D: A multimode cavity filter designed in FD3D.

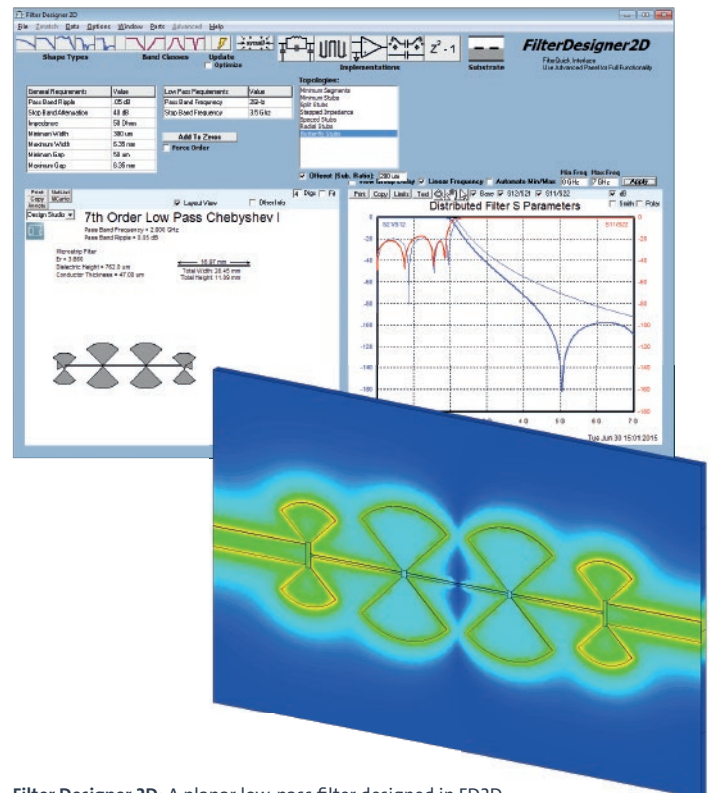

Filter Designer 2D: A planar low-pass filter designed in FD2D.

ARRAY SIMULATION

By combining many individual elements to form an array, engineers can produce antennas with performance superior to a single component. With the correct excitation, arrays can be used to form and steer the beam, allowing an array to scan the environment or track a moving receiver. CST STUDIO SUITE can be used to develop both **small** and **large arrays**, from the design of the individual element to simulation of the full system including feeds and radomes.

MIMO (multiple-input, multiple-output) is a technology widely used in mobile communication to take advantage of multipath propagation and improve reception in complex environments, and forms the basis of **smart** and **cognitive antennas**.

CST STUDIO SUITE includes a toolbox of special features for calculating performance metrics for MIMO antennas such as multiplexing efficiency and envelope correlation.

For larger arrays, the **Phased Array Wizard** significantly simplifies the array design process. The performance of an individual element can be simulated in order to calculate and optimize the active element pattern and impedance, and a full antenna model can then be created automatically for a full system simulation that can take into account the edge effects and interaction between all elements. The link to the array synthesis tools in Antenna Magus helps users to find a suitable layout and excitation for their array.

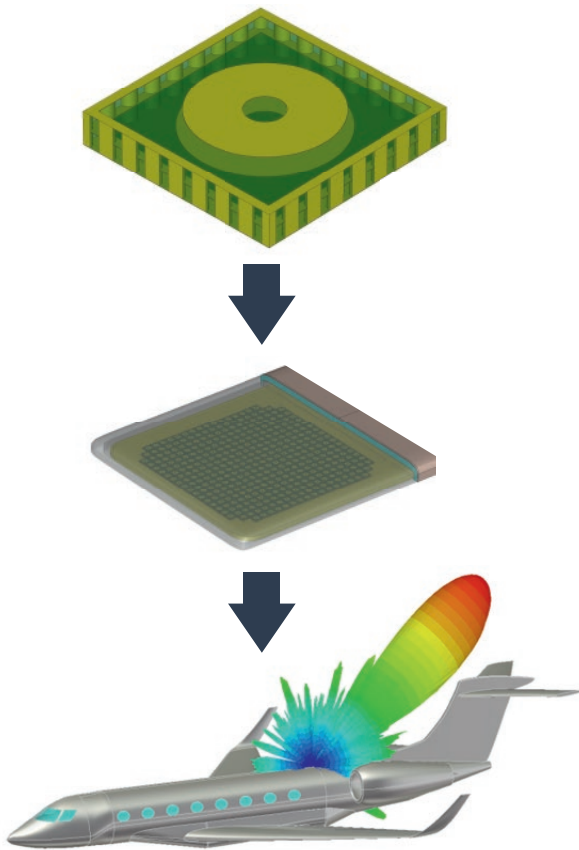

Communication array simulation: The stages of designing a phased array, from the individual element (top), through array layout and radome design (middle) to the final installed performance evaluation (bottom).

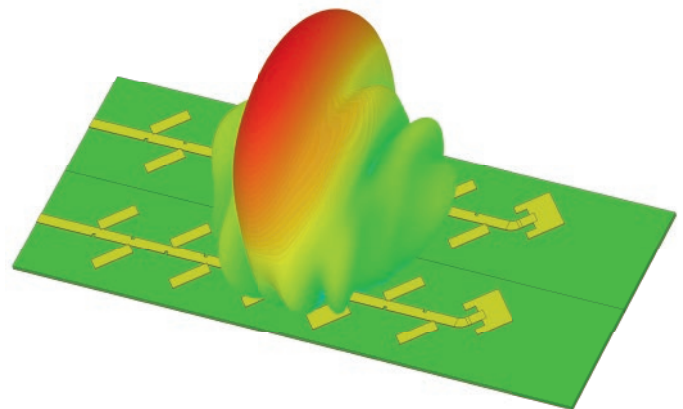

Patch array: This ADAS automotive radar array was optimized for 77 GHz.



SOLVER COUPLING AND HYBRID SIMULATION

Each simulation method has its own strengths, and each one is well-suited to a certain type of problem. However, many real world systems don't fit neatly into one category, but instead straddle the borders between different fields of engineering. To simulate these systems, simulations in CST STUDIO SUITE can be coupled in a number of ways, from circuit-level

representation with true transient EM/circuit co-simulation, through hybrid methods such as the cable solver and the time domain-integral equation hybrid task, to field-source coupling of 3D simulations. This means simulations can be hybridized, so that the strengths of multiple solver types can be combined within a single problem.

EXAMPLE 1: ELECTROSTATIC DISCHARGE ON A CAR



Car chassis: Electrically large at the relevant frequency, with fine details and large amounts of empty space. Well suited to the **Transmission-Line Matrix (TLM) Solver**.

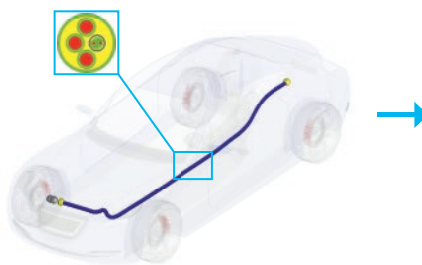

Cable harness: Complex structure, very narrow, but very long. Well suited to **CST CABLE STUDIO**.

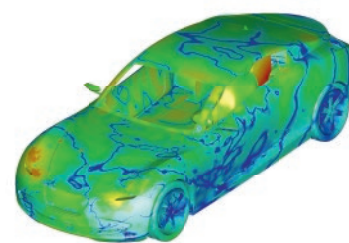

Bidirectional hybrid cable simulation: Enables fields to couple into the cables at one place in the model and be conducted to another, allowing coupling paths to be identified.

EXAMPLE 2: REFLECTOR ANTENNA PERFORMANCE

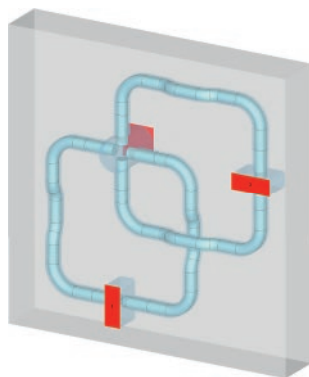

Orthomode Transducer: Narrowband. Well suited to the **Frequency Domain Solver**.

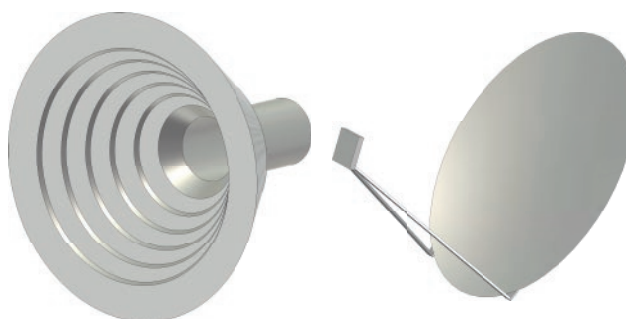

Horn antenna: Broadband. Well suited to the **Transient Solver**.



Reflector dish: Electrically large. Well suited to the **Integral Equation Solver**.

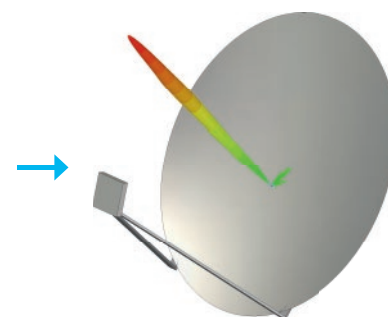

Circuit-level coupling and the Hybrid Solver Task can be used to cascade the simulation of each component and calculate the performance of the whole assembly.

SYSTEM ASSEMBLY AND MODELING (SAM)

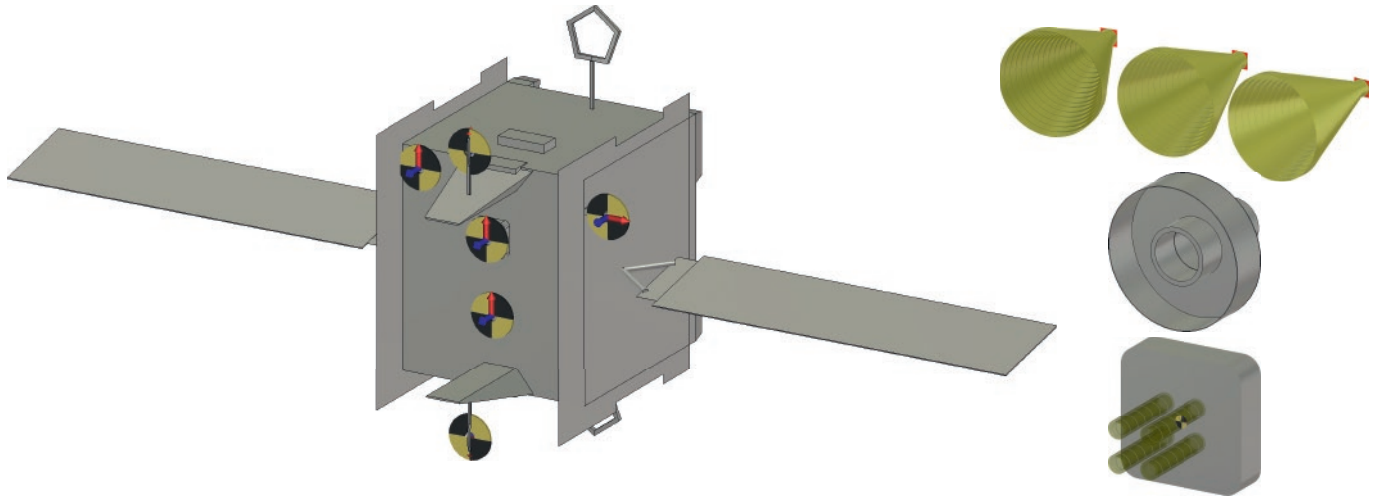

System Assembly: A bare satellite chassis, with anchor points for antenna placement marked, and a selection of antenna types.

System Assembly and Modeling (SAM) simplifies the management of simulation projects in CST STUDIO SUITE. A device may consist of more than one component, each of which may work best with a different solution method, or might require several linked simulation and processing stages to produce the data the user needs. SAM provides a framework for carrying out simulations and optimizations of entire systems, both component by component using hybrid and multiphysics methods, and as an assembled device.

In SAM, a system is described by a circuit schematic and/or 3D assembly. In the simplest case, this is a single block representing a parameterized 3D model. The user defines the calculations to be carried out by setting up simulation tasks, so that the simulation tasks can be linked and data from one simulation can cascade to the next. For example, the electromagnetic analysis of

a filter could be followed by a thermal simulation, and then a mechanical deformation simulation, and finally this geometric change could be used in another electromagnetic simulation to investigate the detuning effect. All simulations and links can be defined easily in SAM to enable a true multiphysics workflow.

By adding more models to the schematic, the user can create a 3D system, using the new Assembly Modeler to define the geometric alignment of the various components. Simulation tasks can be defined that include single or multiple components, and the user can specify which solver and high-performance computing options should be used for each part. Combining different levels of simulation complexity helps to reduce the computational effort required to analyze a complex model accurately. If required, SAM also enables the user to link simulation tasks with field sources, or to create and simulate the system in full 3D.

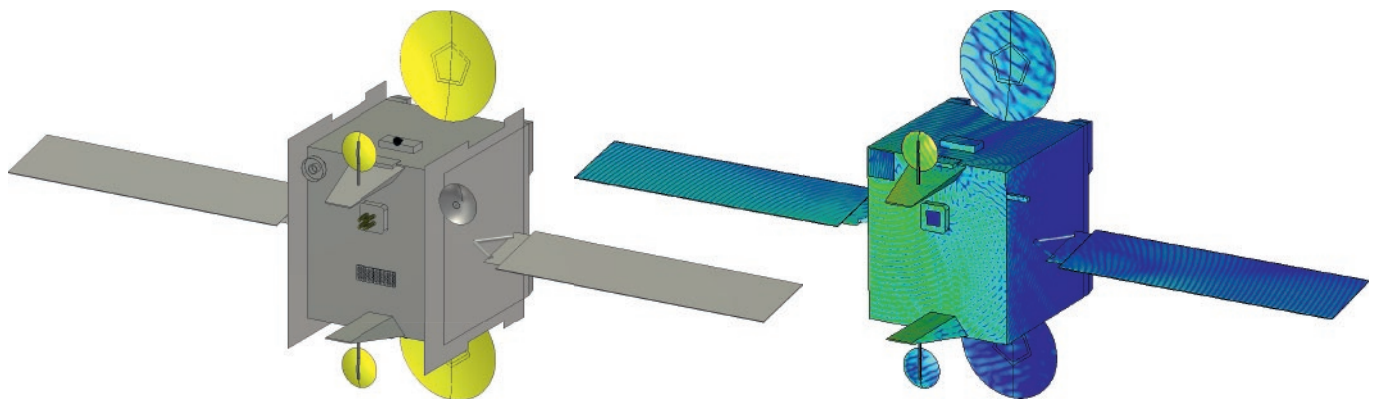

System Modeling: With SAM, the components can be combined into a single model or linked using field source couplings for hybrid simulations.

ANTENNAS

Antenna design is one of the largest applications of CST STUDIO SUITE, and there are many antenna workflows to suit a wide range of application areas. Antennas can be designed and optimized on their own, but also as part of an array at a unit cell and full array level, or as installed in a device or on a larger structure such as a building, aircraft, ship, or satellite.

Complete Technology gives engineers a powerful toolset for studying installed performance of antennas on vehicles, aircraft and masts, as well as embedded antennas in electronic devices. This can overlap with biological EM simulations (see page 24), allowing users to calculate antenna performance and specific absorption rate (SAR) for devices in close proximity to the body.

The link to the CST product Antenna Magus makes it easy for users to find and design the appropriate antenna for the specifications, and to create a model for further simulation.

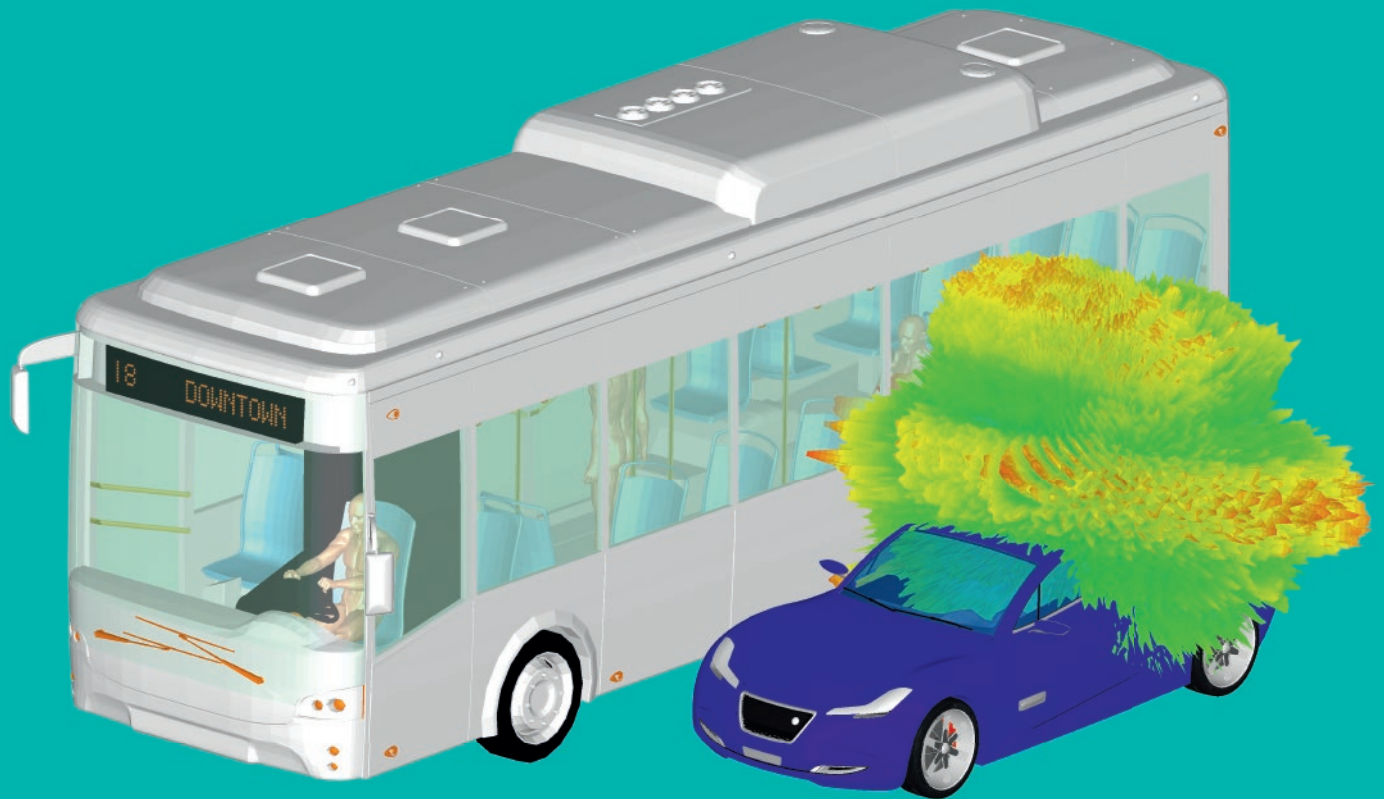

Installed performance: Radiation pattern for a V2V antenna on a car shadowed by a bus.

The simulation of high frequency electromagnetic fields is one of CST's core competencies. CST STUDIO SUITE includes tools for a very wide range of microwave and RF applications, allowing full-wave and hybrid simulation, multiphysics workflows and 3D/circuit co-simulation.

Planar and waveguide **RF components** can be optimized individually or as part of a larger system. SAM (see page 21) is very useful for designing microwaves and RF systems, allowing multiple components to be assembled and simulated together.

This can accelerate system design and makes it possible for the installed performance to be considered at an earlier stage, taking the coupling between elements to be taken into account.

Filter design and synthesis is a major application of CST STUDIO SUITE, with links to a range of specialized CST tools that widen the filter design capabilities significantly. CST's filter design tools allow fast but accurate synthesis and tuning of filters, even those that are very sensitive or with complex topologies (see page 18).

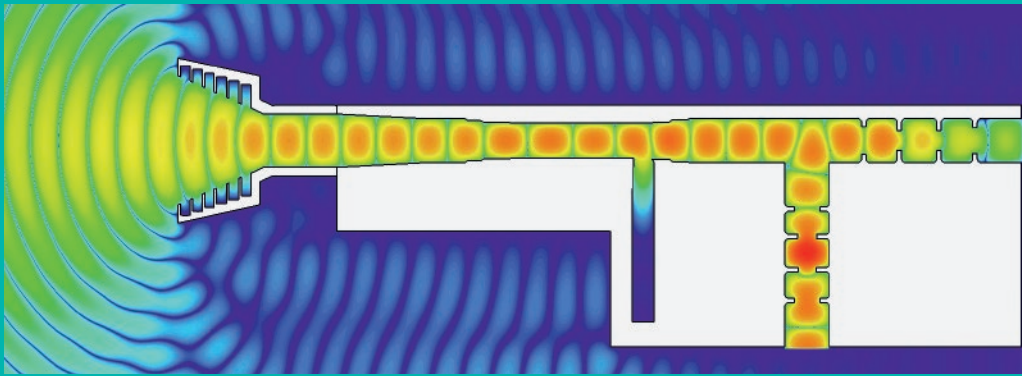

Satellite feed system: Diplexers, orthomode transducer, waveguide transition and feed horn, assembled using SAM.

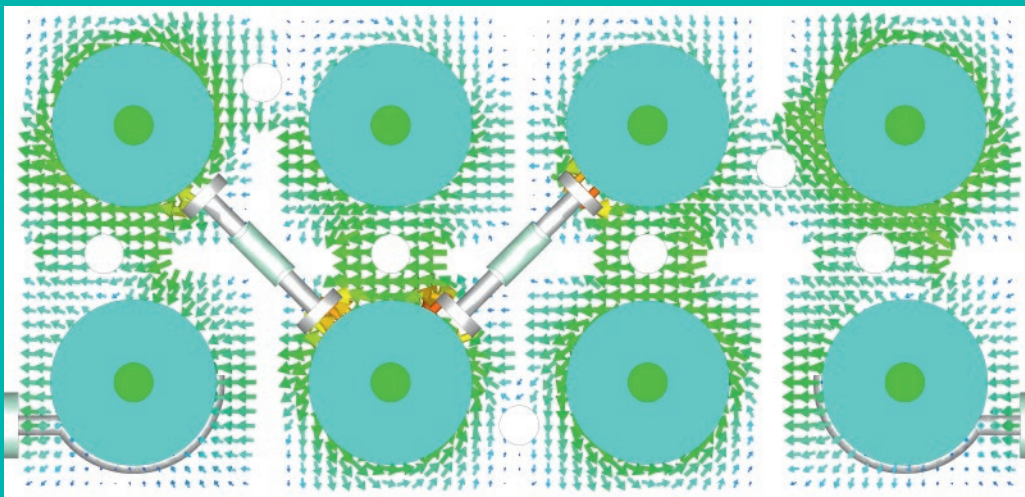

Cavity filter: A cross-coupled dielectric resonator filter with transmission zeroes, designed and tuned in CST STUDIO SUITE.



BIOLOGICAL ELECTROMAGNETICS (BIO-EM)

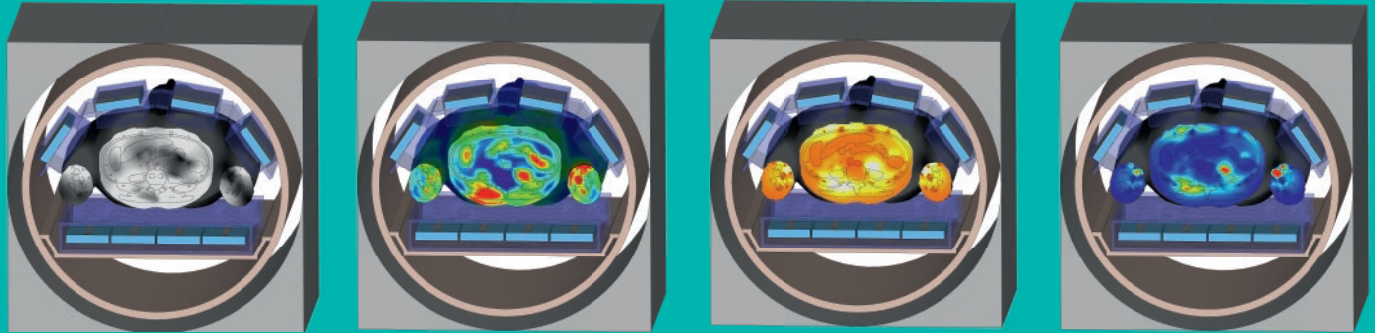

MRI: Flexible array for a 7 T MRI, with a human voxel model, showing (left-to-right) B1+ field distribution, point SAR, temperature after 10 minutes and thermal dose (CEM43°C). Courtesy of German Cancer Research Center (DKFZ).

The interaction of electromagnetic fields and the body is relevant both to modern communication devices such as mobile phones and to new technologies such as the internet of things and advanced medical systems for monitoring, imaging and treatment. As measurement is typically not an option inside the human body, EM simulation is the only way to analyze the complex field distribution inside the body, to ensure the functionality of the device as well as to understand and to avoid hazards due to the power absorption inside the tissues.

The accurate simulation of EM propagation within the body therefore requires accurate models of both the complex anatomical structure and of the tissue properties, which typically vary over age, frequency and temperature. CST offers both voxel-based and CAD-based body models representing a range of ages, sizes and sexes, as well as a material library with the properties of many different tissue types, and a posing tool for voxel models.

All electromagnetic devices in the vicinity of the human body require certification by governmental authorities, mainly based on statistic field evaluation (e.g. required by ICNIRP standards) or the specific absorption rate (SAR), which is a measure of how much energy is absorbed by the body. CST STUDIO SUITE can directly calculate all types of SAR, such as point SAR, 1g and 10g-average SAR and whole-body SAR. This allows engineers to evaluate the SAR values even in the early stages of the product design.

Heating is another important consideration when designing devices for use within or nearby human bodies. In some

medical devices, such as for cancer treatment, this is a desired effect, while in other applications it is unwanted. CST STUDIO SUITE includes a multiphysics module with bio-heat solvers that can calculate temperature distributions and the thermal dose (CEM 43°C) including effects of living tissues such as metabolic heating, blood diffusion and human thermo-regulation. For more information, see Multiphysics (page 7).

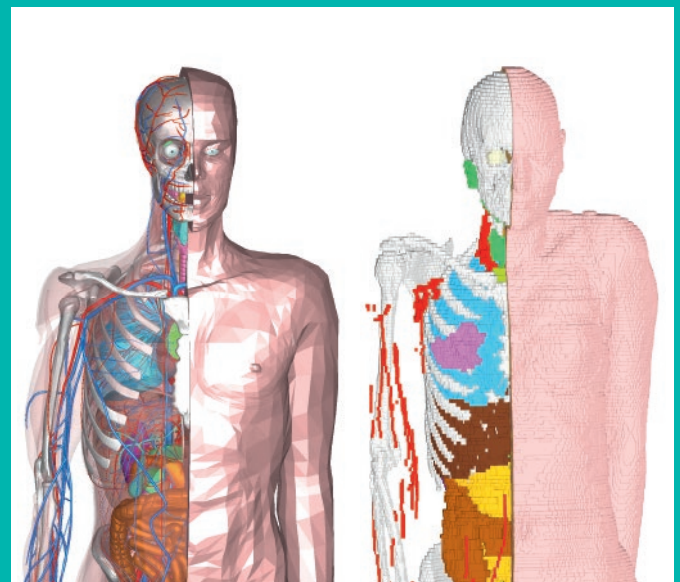

Body models: CST offers both CAD-based (left) and voxel-based (right) body models suitable for EM simulation.

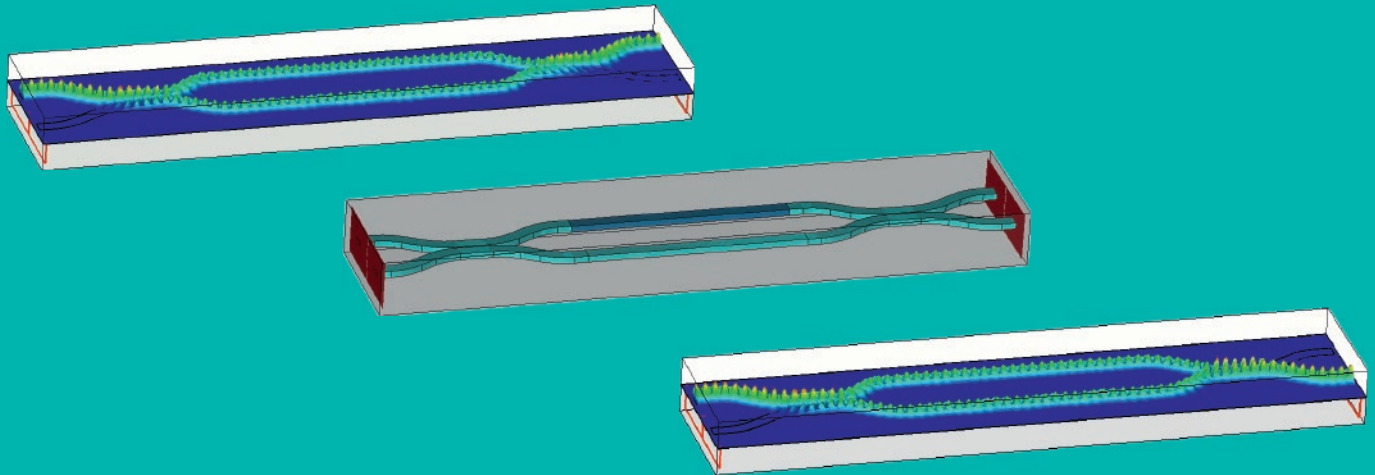

Non-linear behavior: The output is switched by locally applying an external field to part of the waveguide, changing the refractive index in one of the straight sections. The resulting change in phase leads to destructive interference in either the upper or the lower output channel.

Optical, photonic and plasmonic devices are already key components in many areas, such as communications, remote sensing, or medical applications, and their role will only increase in the future. Simulating such devices helps in optimizing their efficiency and in reducing cost of design and development. CST STUDIO SUITE has dedicated workflows for optical devices.

Non-linear effects are often exploited in optical devices, and so CST includes a range of non-linear material models (see page 6). The very short wavelengths involved mean that optical components often require simulating electrically extremely large structures. Typical examples include grating couplers or waveguide bends. High-performance computing (see page 11) offers an effective approach for the full-wave simulation of these devices.

“In my group we frequently use CST STUDIO SUITE for our studies on optical metamaterials and plasmonics, and we love it for its user friendliness, the simulation accuracy, and the flexibility in modeling complex problems.”

A. Alù, Associate Professor, University of Texas at Austin



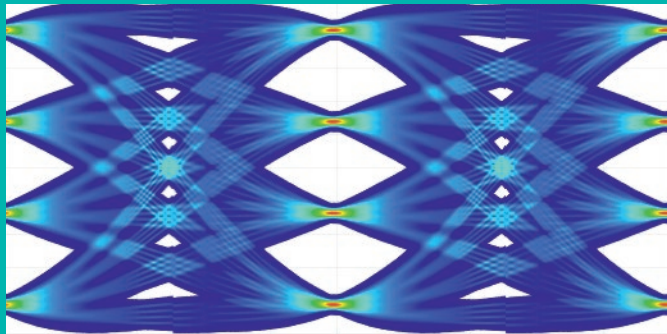

Signal integrity: A multi-level eye diagram generated in CST STUDIO SUITE.

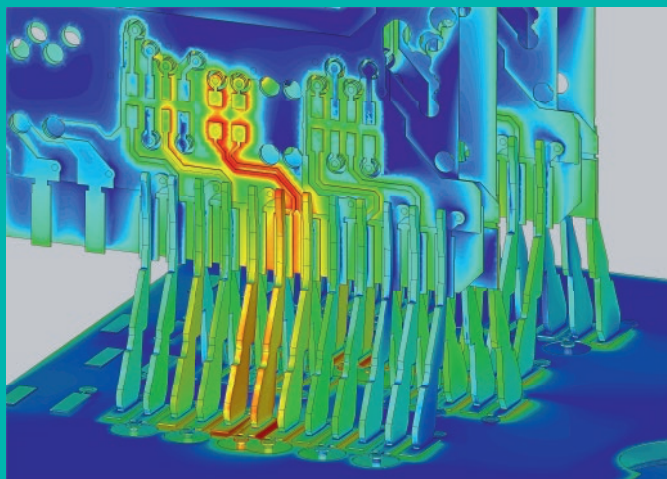

Channel modeling: Electric field on a DDR4 RAM memory channel.

With the high data rates, compact structure and complex layout of modern circuit boards and packages, maintaining **signal integrity (SI)**, **power integrity (PI)** and **electromagnetic compatibility (EMC)** can be difficult. CST STUDIO SUITE contains a number of tools to help engineers design, analyze and improve PCB layouts.

The dedicated PCB simulation tools in CST STUDIO SUITE can be used to characterize the behavior of a layout quickly. These can be used to characterize effects such as **voltage drop**, **power distribution network (PDN) impedance** and the **transmission behavior** of signal nets. Decoupling capacitors can be optimized automatically using Pareto frontier optimization to balance price against performance. CST STUDIO SUITE also includes a rule-checking tool for PCB layouts, CST BOARDCHECK, which can automatically detect structures that may cause SI/PI or EMC problems.

Layouts can be converted directly into a 3D model for full-wave simulation or into an equivalent circuit model for circuit simulation, with specialized meshing algorithms optimized for complex printed structures. IC designs can be imported through the **chip interface**, which mimics the real fabrication process to produce accurate simulation models.

Simulation allows many standard test-lab measurements such as S-parameters, eye diagrams and time-domain reflectometry (TDR) to be replicated using a virtual prototype, which can help reduce the cost and duration of the design cycle.

“Using CST MICROWAVE STUDIO to model EMC and EMI performance has given us the competitive edge with our customers, and has enhanced their trust in our products.”

Ralf Kakerow, Continental Automotive GmbH

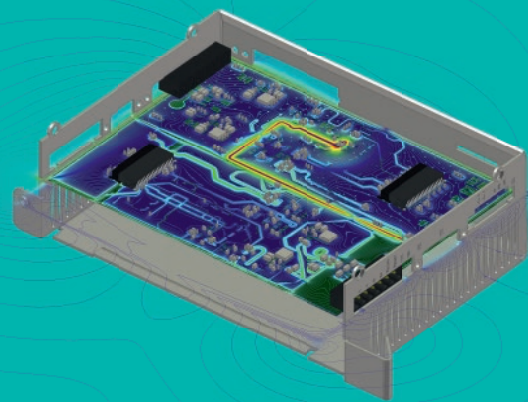

Emissions: Radiated emissions from a PCB.

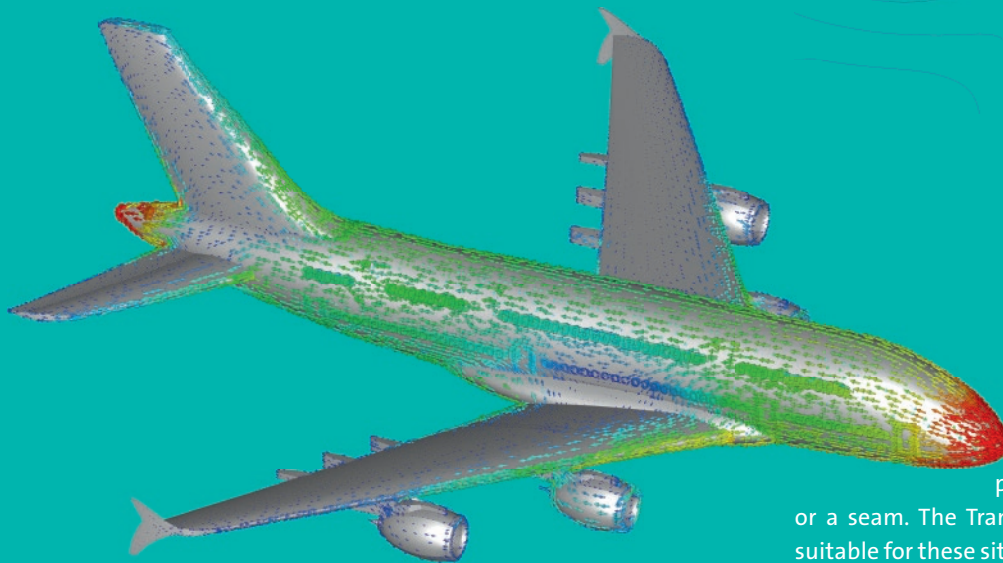

E3: Surface currents on an aircraft during a lightning strike, flowing from nose to tail.

Electromagnetic compatibility (EMC) and electromagnetic interference (EMI) are two sides of the same coin. For EMC compliance, the device under test must not produce **conducted or radiated emissions** that can disrupt other devices, while for EMI immunity, the device must be able to withstand expected interference, whether from nearby devices or from **electromagnetic environmental effects (E3)** such as lightning strikes or electromagnetic pulse (EMP).

For simulating electronic devices, the full-wave solvers can be supplemented by circuit simulation in CST DESIGN STUDIO, which is included with all CST STUDIO SUITE licenses. **True transient EM/circuit co-simulation** allows component models such as SPICE and IBIS files to be included in the 3D simulation of the device. PCB layouts can also be examined for potential EMC problems using the rule-checking tool CST BOARDCHECK.

EMC/EMI and E3 problems can arise from seemingly insignificant details in a complex structure – for instance, a cable, a vent or a seam. The Transmission Line Matrix (TLM) Solver is very suitable for these situations, and supports compact models that can efficiently model complex structures.

Coexistence is an important concern, both between RF systems on a single platform, and between data buses run at high clock speeds with harmonics spreading well into the RF frequencies. Such RF interference results in performance degradation of these systems and is not acceptable. The CST **Interference Task** analyzes inter-system coupling and delivers an overview of possible RF interference. The interference tool is fully integrated into CST STUDIO SUITE, making it easy to run different scenarios and test mitigation strategies after the detection of possible interference.

Cables can pick up fields emitted in one part of the structure, conduct them to another part, and then re-radiate them, causing further EMI problems. The Time Domain Solver can be supplemented with **hybrid transient cable simulation**. This allows analytical cable and cable harness models to be integrated into the 3D model.



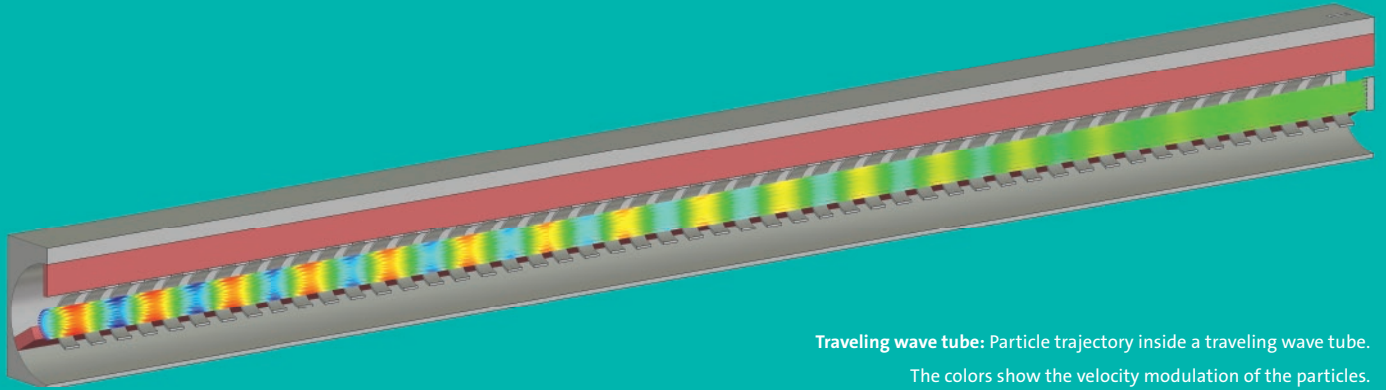

Traveling wave tube: Particle trajectory inside a traveling wave tube. The colors show the velocity modulation of the particles.

CST software has been used in particle accelerator facilities since its earliest days. CST STUDIO SUITE includes several tools for designing charged particle devices ranging from microwave devices such as magnetrons and electron tubes to ultrarelativistic components for particle accelerators.

For particles in static fields, the **Particle Tracking Solver** can quickly calculate their trajectory through the device, making it a useful tool for electron and ion gun design. The space charge of the particles can be included during the simulation via an iterative approach. The **Particle-in-Cell (PIC) Solver** is a self-consistent solver taking the fields produced by the particles directly during a single solver run into account. Therefore, it is suitable for devices such as **magnetrons**, **klystrons** and **traveling wave**

tubes where the non-linear interaction between particles and field is important. The PIC Solver can be also used for **multipaction** analysis. **GPU acceleration** can be used to improve the performance of the PIC solver further.

To help with component design, the **Wakefield Solver** calculates the fields around particle bunches travelling through the accelerator. These particles produce significant wakefields which can interact with structures inside the accelerator such as **collimators** and **beam detectors** and disrupt the beam. For components with a very high Q factor, such as **accelerator cavities**, the eigenmode solver offers a quick calculation of the resonant modes of the cavity – these can then be used as the basis of a PIC simulation.



Particle trajectory in a klystron: A PIC Solver simulation of a 1.24 m klystron. The bunching which produces the RF signal is clearly visible.

“CST EM STUDIO is now an integral part of the development process of various power transformer components at Siemens (Energy). This is especially a consequence of the intuitive user-interface and the variety of available solvers.”

Ronny Fritsche, Siemens AG Sector Energy T TR PN

The aims and requirements of low frequency simulation are very distinct from those of high frequency simulation. CST STUDIO SUITE includes a dedicated module for low frequency, static and quasistatic simulations.

The high voltages and large currents used in power transmission networks mean that devices such as **transformers**, **switchgears** and **insulators** need to be designed robustly to maintain reliability and safety. The low frequency solvers in CST STUDIO SUITE can calculate fields and current flows through these devices, including effects such as eddy currents. The results can then be used in a **multiphysics** simulation to calculate the heating effect of the currents and the possible thermal expansion of the structure.

Low frequency simulation is also useful for designing **magnetic devices**. Coils and magnets can be defined easily, and **non-linear materials** such as ferromagnets are supported. CST STUDIO SUITE can calculate not only the fields within the device, but also the **forces** and **torques** acting on the various components. These features can be used to design **motors**, **generators**, **actuators** and **sensors**.

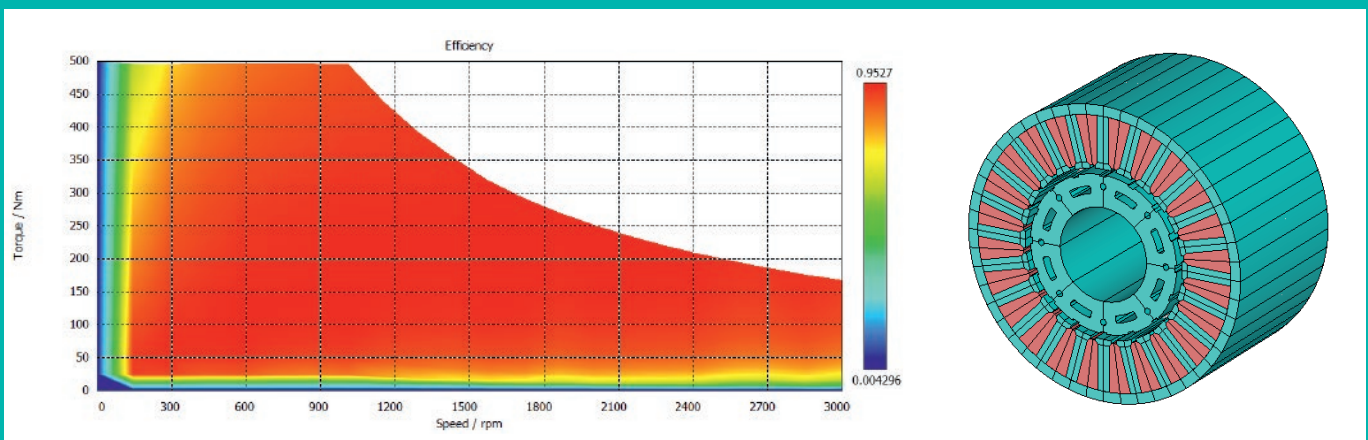

Motor simulation: The efficiency map for a motor can be automatically calculated with the built-in wizard.





CST STUDIO SUITE

The modules that make up CST STUDIO SUITE are tightly integrated, giving users access to the entire range of solver technology and allowing circuit and multiphysics co-simulation.



CST MICROWAVE STUDIO: our industry-leading tool for the fast and accurate simulation of high frequency devices. Applications areas include microwaves & RF, optical applications, EDA/electronics and EMC/EMI.



CST EM STUDIO: for the design and analysis of static and low frequency EM applications such as motors, sensors, actuators, transformers and shielding enclosures.



CST PARTICLE STUDIO: a specialized product dedicated to the fully consistent simulation of free-moving charged particles. Applications include electron guns, traveling wave tubes, magnetrons and wakefields.



CST CABLE STUDIO: for signal integrity and EMC/EMI analysis of cables and cable harnesses.



CST PCB STUDIO: for the simulation of signal and power integrity effects and EMC/EMI on printed circuit boards.



CST BOARDCHECK: a rule-checking program that reads popular board file formats and checks the PCB design against a suite of EMC and SI rules.



CST MPHYSICS STUDIO: a multiphysics module for thermal simulations and mechanical stress analysis.



CST DESIGN STUDIO: a versatile tool that facilitates 3D EM/circuit co-simulation, system simulation and synthesis.

CST – COMPUTER SIMULATION TECHNOLOGY

ABOUT CST

CST is a market leader in providing 3D electromagnetic (EM) field simulation tools through a global network of sales and support staff and representatives. CST develops CST STUDIO SUITE, a package of high-performance software for the simulation of EM fields in all frequency bands. Its growing success is based on a combination of leading edge technology, a user-friendly interface and knowledgeable support staff. CST solutions are used by market leaders in a diverse range of industries, including aerospace, automotive, defense, electronics, healthcare and telecommunications. CST is part of SIMULIA, a Dassault Systèmes brand.

Further information about CST is available on the web at www.cst.com

ABOUT SIMULIA

The SIMULIA brand of Dassault Systèmes enables users to leverage physics-based simulation and high-performance computing to power sustainable innovation for products, nature, and life. Powered by Dassault Systèmes 3DEXPERIENCE platform, SIMULIA realistic simulation and optimization applications accelerate the process of making mission-critical design and engineering decisions before committing to costly and time-consuming physical prototypes.

www.3ds.com/simulia

ABOUT DASSAULT SYSTÈMES

Dassault Systèmes, the 3DEXPERIENCE Company, provides business and people with virtual universes to imagine sustainable innovations. Its world-leading solutions transform the way products are designed, produced, and supported. Dassault Systèmes' collaborative solutions foster social innovation, expanding possibilities for the virtual world to improve the real world. The group brings value to over 210,000 customers of all sizes, in all industries, in more than 140 countries.

www.3ds.com

TRADEMARKS

CST, CST STUDIO SUITE, CST MICROWAVE STUDIO (CST MWS), CST EM STUDIO, CST PARTICLE STUDIO, CST CABLE STUDIO, CST PCB STUDIO, CST MPHYSICS STUDIO, MPHYSICS, CST MICROSTRIPES, CST DESIGN STUDIO, CST EMC STUDIO, CST BOARDCHECK, PERFECT BOUNDARY APPROXIMATION (PBA), Antenna Magus, the CST logo, 3DEXPERIENCE, the Compass icon, the 3DS logo, CATIA, SOLIDWORKS, ENOVIA, DELMIA, SIMULIA, GEOVIA, EXALEAD, 3D VIA, BIOVIA, NETVIBES, IFWE and 3DEXCITE are commercial trademarks or registered trademarks of Dassault Systèmes, a French "société européenne" (Versailles Commercial Register # B 322 306 440), or its subsidiaries in the United States and/or other countries. All other trademarks are owned by their respective owners. Use of any Dassault Systèmes or its subsidiaries trademarks is subject to their express written approval. DS Offerings and services names may be trademarks or service marks of Dassault Systèmes or its subsidiaries.

© CST 2017 | CST, a Dassault Systèmes company | CST STUDIO SUITE® is a CST® product | www.cst.com

